

GRANDE GR 10

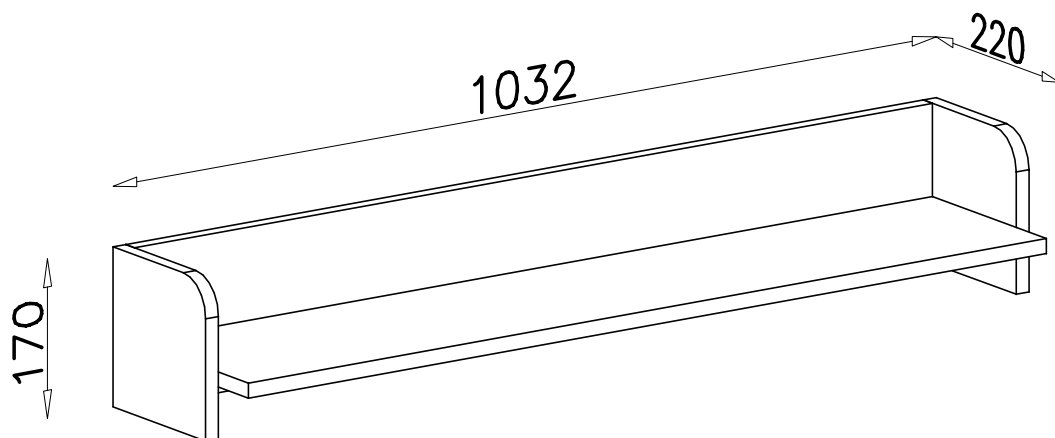

W1

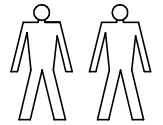
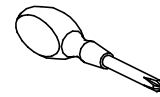
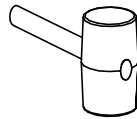
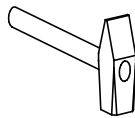
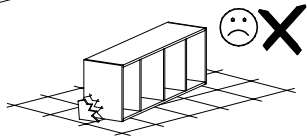
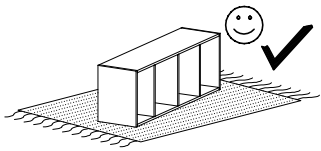

x1

G4



4x16

x4

I7



ø18

x4

U4

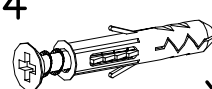

x2

U12



x2

A1

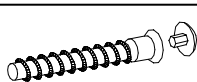

ø7x50

x4

B7



ø8x30

x12

W2

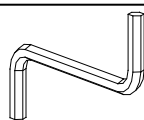

x1

K5

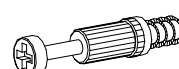

x4

K1



ø15x12

x4

I

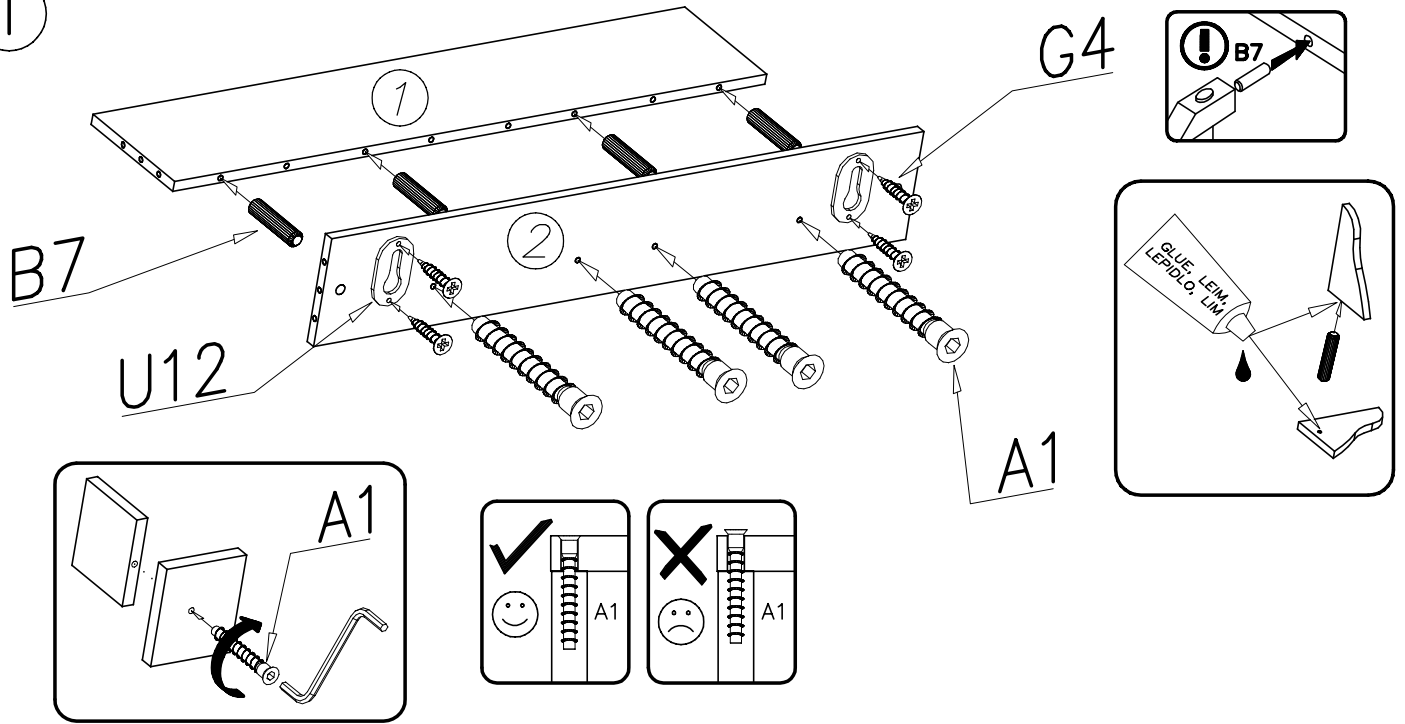

II

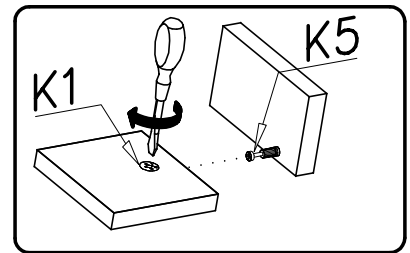
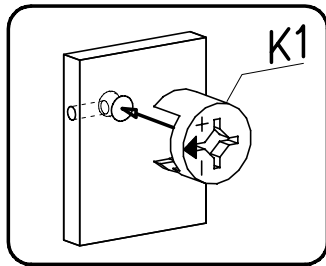
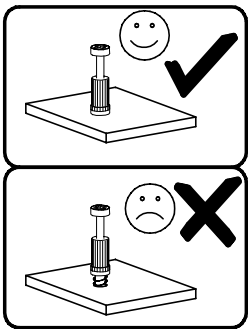
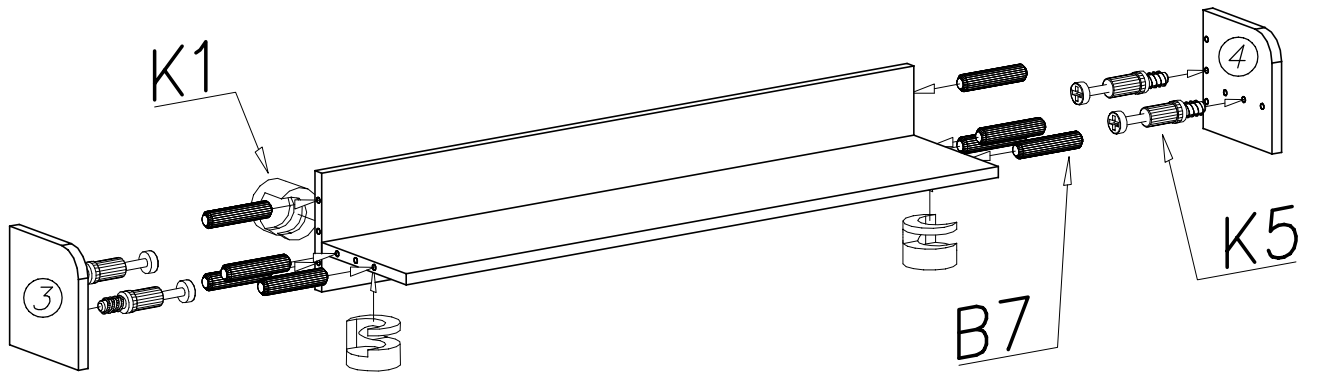

III

